

Sento verticale up datasheet

LED wall mounted luminaire with a high base, in which the power supply unit (converter) is included for mounting on fixed ceiling or wall, connection to 230V. Modular LED head-body-system allows free combination of different surfaces of head, body and base. Removable head for configuration and maintenance purposes, LED changeable. Heads available with one sided or double sided light output, power of light source 18W or 26W.

Lighting effect changeable by using optional inserts, dichroic color filters can be added. Adjustment via heat-decoupled carbon pin (fixation of head against rotation optional). Dimmable via external trailing edge phase-cut dimmer or via »touchless control« with gestures at the head.

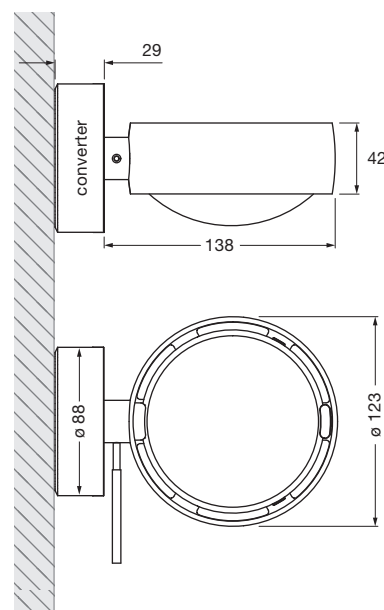

dimensions in mm

technical data Sento verticale up

properties	material	aluminium, steel chrome-plated, painted or anodised, plastic, glass, optical plastic		
	length	138 mm including head		
	rotation head	360°		
	weight	1.4 kg		
surface	head	matt gold, rose gold, bronze, shiny chrome, matt chrome, glossy white, matt white, matt black, phantom		
	body	matt white, matt black, shiny chrome, matt chrome		
	base	shiny chrome, glossy white, matt chrome, matt white, matt black		
Occhio LED	average life time	> 50.000 hrs		
	energy efficiency class	A+ / A		
	power single sided / double sided	26 W / 18 W		
	color rendering index	perfect color; CRI Ra 97	high flux; CRI Ra 85	
	color temperature	2700, 3000 K	3000, 3500, 4000 K	
	recommended use	residential and public	public	
electricity	dimming	»touchless control« and Occhio air (optional) or via trailing-edge phasecut dimmer* (depends on driver)		
	power supply unit	integrated, for use with 230 V AC		
	permitted operating conditions	max. 30°C for indoor use only		

* For a list of compatible dimmers, see www.occhio.de/dim_en, trailing-edge phasecut dimmer and Occhio air not combinable



Sento verticale up lighting effects

 head single sided

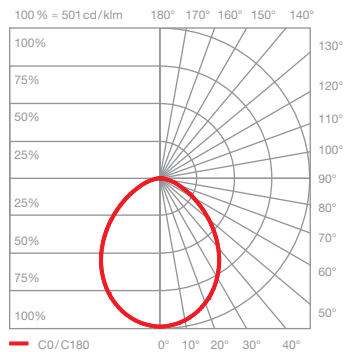
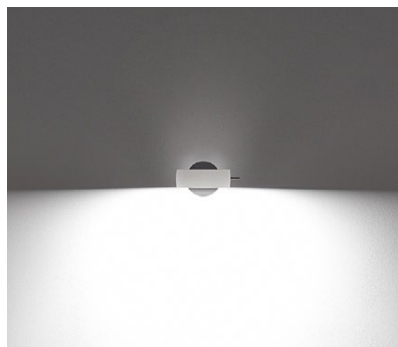

Sento B

diffuse light

insert: diffusor glass

luminous flux:	perfect color	26 W	1370lm
	high flux	26 W	1870lm
	perfect color	18 W	1000lm
	high flux	18 W	1370lm

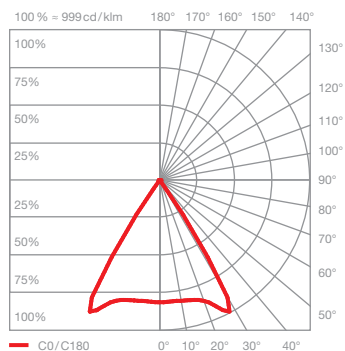

Sento C

directed light
beam angle approx. 80°

insert: lens

luminous flux:	perfect color	26 W	1570lm
	high flux	26 W	2150lm
	perfect color	18 W	1140lm
	high flux	18 W	1570lm

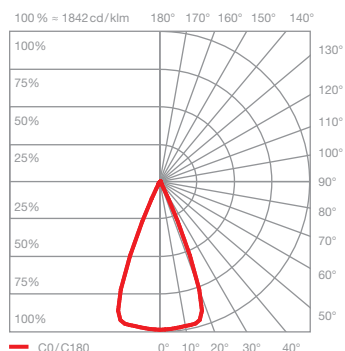
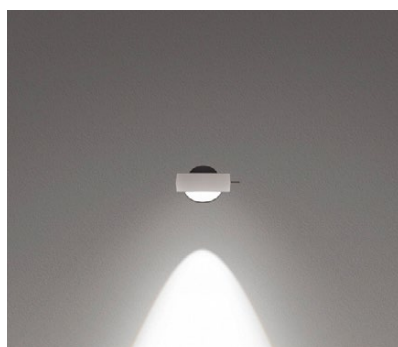

Sento S40

directed light
beam angle approx. 40°

insert: spot lens, lens
soft edge glass

luminous flux:	perfect color	26 W	1560lm
	high flux	26 W	2130lm
	perfect color	18 W	1130lm
	high flux	18 W	1560lm

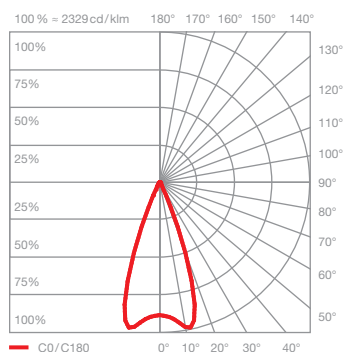
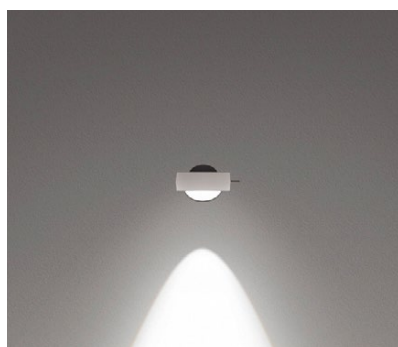

Sento S30

directed light
beam angle approx. 30°

insert: spot lens, lens
fresnel lens

luminous flux:	perfect color	26 W	1530lm
	high flux	26 W	2080lm
	perfect color	18 W	1110lm
	high flux	18 W	1530lm

Sento verticale up lighting effects

 head double sided

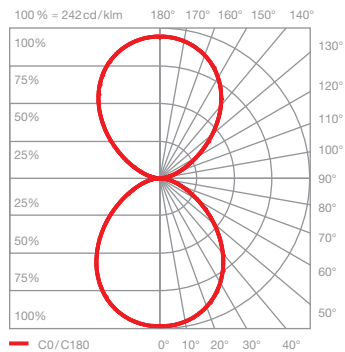
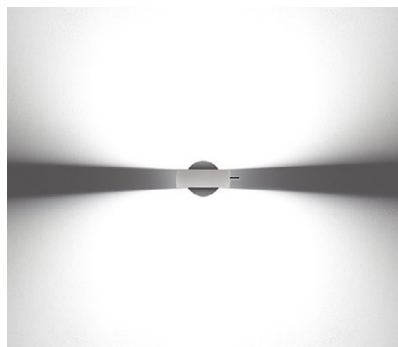

Sento A

diffuse light in both directions

insert: diffuser glass
diffuser glass

luminous flux:	perfect color	26 W	1500lm
	high flux	26 W	2040lm
	perfect color	18 W	1090lm
	high flux	18 W	1500lm

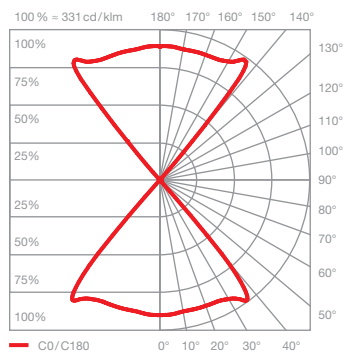

Sento D

directed light in both directions
beam angle approx. 80°

insert: lens
lens

luminous flux:	perfect color	26 W	1750lm
	high flux	26 W	2390lm
	perfect color	18 W	1270lm
	high flux	18 W	1750lm

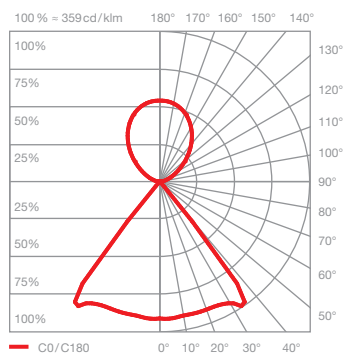
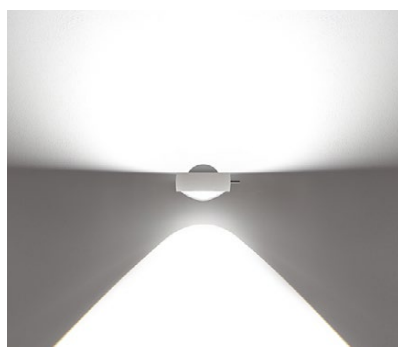

Sento E

diffuse up light
directed down light
beam angle approx. 80°

insert: diffuser glass
lens

luminous flux:	perfect color	26 W	1620lm
	high flux	26 W	2200lm
	perfect color	18 W	1170lm
	high flux	18 W	1620lm